

Der umschaltbare Elektro-Einbauherd
COMPETENCE 840 E

The Convertible Build-In Electric Cooker

La cocina eléctrica conmutable
para montaje empotrado

AEG

Gebrauchsanweisung
Operating Instructions
Instrucciones para el uso

AUS
ERFAHRUNG
GUT

Hello

Allow me to introduce myself: I am your new AEG cooking appliance. From now on, I should like to make boiling and baking more pleasurable for you. Not simply because of my attractive appearance, but also thanks to my "intrinsic qualities". I am economical in terms of energy consumption, easy to operate, and simple to care for. If you carefully read and follow my operating instructions before first use, you are sure to experience a good deal of joy when using me to boil, bake, roast, and grill your food.



Contents

Safety instructions	
For the installer	56
For the user	56-58
Appliance description	
Features	59
First use	
Operating the switches	60
Switching on the electronic timer	61/62
Precleaning the oven	62
Hobs	
Hob user protection	63
Features	64-67
General	68
Operating the hobs	69/70
Variable oven	
General	71/72
Fume extraction	73
Heating modes	74-76
Electronic timer for the oven	77-79
Switching on and off	80
Oven space divider	82/83
Baking	85-87
Baking by microwave	86/87
Roasting and steaming	88/89
Roasting and steaming by microwave	88/89
Flat grilling	90/91
Special preparation methods with hot air	
– Menu cooking	92
– Bottling	93
Microwave	
– Defrosting	94-96
Cleaning and care	
Cooking area	97/98
Oven	98-102
Special accessories	103
What to do if . . .	104/105
Customer services	106

Safety instructions

For the installer

The safety requirements oblige manufacturers to give the following instructions:

For installation in a kitchen unit, my attached installation instructions must be noted.

For the user

Introduction to microwaves

What are microwaves?

Microwaves are electromagnetic waves in a specific frequency range, such as daylight or radio waves, though with the difference that the wavelength is different. Radio waves are emitted into the atmosphere and can cover large distances. As soon as they reach a radio receiver, the energy received is converted into sounds. Microwaves are only emitted inside your appliance.

When they reach the food, the energy received is converted into heat. The microwaves are alternately positive and negative and affect the water molecules of the food like a magnet. The very rapidly progressing polarity change of the microwave causes vibration of the molecules and thereby friction which heats the food from inside. This enables food to be cooked.

The golden rules for trouble-free and safe working with your microwave cooker are:

1. Switch on the microwave only when food has been placed in the cooking space.
2. Always keep your cooker clean, especially in the vicinity of the door seals and door seal surfaces.

3. Never damage:

- the door
- the door hinges
- the door seals and their surfaces
- the door frame

(e.g. never jam anything between door and frame)

Clean the door seals and their surfaces (also the door frame) with a mild detergent and hot water.

Note:

Should the door seals and door seal surfaces be damaged, the cooker should not be operated until it has been repaired by the AEG Service Centre or by an AEG-trained electrician!

4. Only use suitable ovenware.

You will find instructions on page 81.

5. When heating liquids, please always additionally place a tea-spoon in the container to avoid delayed boiling.

During delayed boiling, the boiling temperature is attained without typical steam bubbles rising.

Even when the container is only slightly shaken, the liquid may then suddenly vigorously boil over or spurt.

Risk of scalding!

6. Food with a "skin" or "peel", such as potatoes, tomatoes, sausages, and the like should be pierced with a fork so that any steam present can escape and the food will not burst.
7. Babyfood in jars or bottles should basically be heated without a lid or top and well stirred or shaken after heating to ensure uniform distribution of the heat. Before giving your child the babyfood, please check the temperature.
8. Please note that, at high power and time settings, the ovenware heats up. Therefore use protective mittens suitable for handling hot pans.
9. **Never use your microwave cooker:**
 - to boil eggs in their shells, since they will otherwise burst!
 - to heat large quantities of cooking oil (fondue, deep-frying) and drinks containing a high percentage of alcohol (danger of spontaneous combustion!)
 - to heat unopened cans, bottles, etc.
 - to dry animals, textiles, and paper
 - if no food has been placed in the cooking space.
10. **Use your appliance only as instructed** by the manufacturer and as indicated in the tables. Never overcook your food by excessive times and excessive power settings (especially food with a high sugar content). Specific areas of the food will otherwise dry out and may ignite.

Important note:

When operating your microwave cooker, please always use the combination grid and suitable ovenware, such as heat-resistant glass containers or the ovenware from our range of accessories. You will find instructions on page 81.

AEG electrical appliances comply with the valid safety requirements. Never use your microwave cooker if it no longer operates in a trouble-free manner. To ensure the safety of your appliance, you should have repairs, especially on live parts, carried out only by AEG trained electricians. In the event of a fault, you must therefore contact your retailer or our service centre direct. Improper repairs may place the user at serious risk (an exception is given on page 100 under Cooking space lighting).

For the user

- **If you use my variable oven, my heated partition should only be placed in my oven complete (lower part with heating element and cover).**
- When you use me to prepare your food, my hobs and the oven door become hot. Therefore keep small children well away from me.
- **This especially applies when you are grilling or pyrolytically cleaning my oven (if available).**
- Overheated fats and oils rapidly ignite. When using me to prepare food in fat or oil (e.g. chipped potatoes), please remain nearby.
- Do not use me to heat your room.
- Take care when connecting electrical appliances to plug sockets in the cooker vicinity. Connection leads should not come within reach of hot hobs/cooking zones or get trapped under the hot oven door.
- To avoid damage to my glass-ceramic surface, you should not use my cooking area as a storage area.
- My glass-ceramic cooking area (**if available**) is extremely resistant, though not unbreakable. It may be damaged by any sharp or hard objects falling on to the cooking surface. Should any fractures, cracks, or other defects appear, I must be separated from the mains supply by the device required on the fixed wiring side. Before doing so, please switch my 4 hob switches to 0.
- Never line my oven floor with aluminium foil and never place any pan, pot, etc. on my floor, since the oven enamel will otherwise be damaged by the heat congestion caused.
- Fruit juices dripping from the oven sheet leave stains that you will find hard to remove.
- I comply with radio interference suppression specifications EN 55014 (previously EC Directive 82/499) and as appropriate with EN 60555 relating to the Retroactive Effect on the Mains Supply.

Appliance description

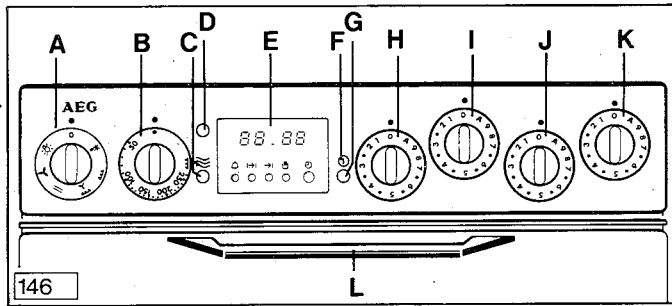

- A** Switch for oven cooking functions, illuminated
- B** Switch for oven temperatures, illuminated
- C** Combination button for switching my microwave on and off during combined operation
- D** Oven pilot lamp (red) lights up when my oven is heating
- E** Electronic timer with time of day display, short-term alarm, and automatic switch-on/off for oven only
- F** Pilot lamp (red) for user protection display
- G** User protection button
- H** Switch for front LH Automatic 2000 hob, illuminated
- I** Switch for rear LH Automatic 2000 hob, illuminated
- J** Switch for front RH Automatic 2000 hob, illuminated
- K** Switch for rear RH Automatic 2000 hob, illuminated
- L** Handle for opening my oven door

Features

First use

Operating the switches

My switch A can be turned both right and left from any position. Further information on this feature is given in the "Hobs" and "Oven" sections.

You must be a little more careful with my switches B for the oven temperatures and H, I, J, and K for the automatic hobs.

You can only turn switch B as far as the flat grilling symbol  and switches H, I, J, and K only to the right (clockwise) to their fullest extent.

They are reset by turning to the left.

If you switch on my switch A, it and switch B are illuminated.

Press my combination button C whenever you want to use one of my cooking functions (top/bottom heat, hot air, or Infratherm grilling) together with the microwave.

When the combination button C is pressed, the microwave symbol  lights up above it.

The hob switches are individually illuminated after being switched on.

When the cooking sequence has ended, switch off my microwave by repressing button C. The pilot lamp with the microwave symbol  goes out.

As soon as I am connected to the mains supply (and also after each power failure), the display in my electronic timer flashes 00.00.

Switching on the electronic timer for the oven only

Only when you have set me to the corresponding time of day am I ready to operate.

Setting the time of day

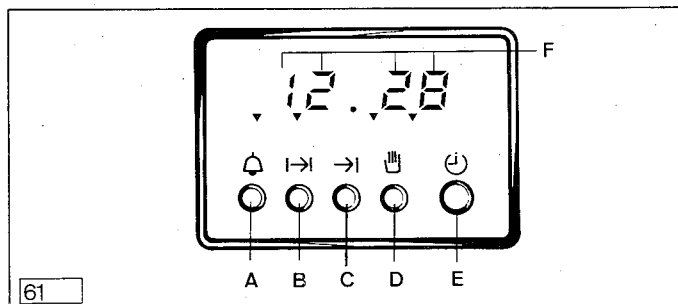

- Press knob E (power icon), which will retract for operation (but can be pressed back in if not needed).
- Press buttons A (bell icon) and B (left arrow icon) at the same time, hold them in position, and set the actual time of day with my knob E (power icon).

The time of day appears for you in display F.





- The red triangle above button D (hand icon) for automatic operation flashes. It is cancelled by pressing button D.

Only now is my oven ready to operate.

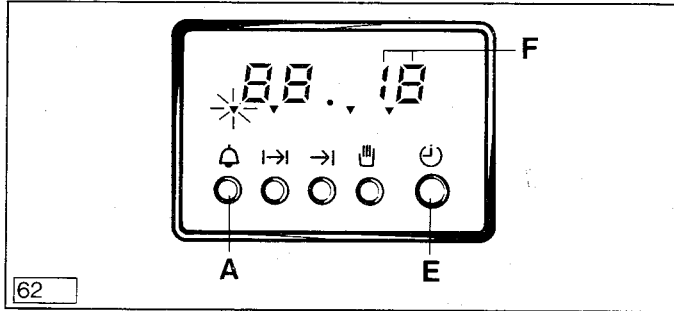
You should also be aware of the following

Setting the short-term alarm (no switch function)



- Press button A , hold it in position, and set the required time with my knob E . The duration appears in display F. The red triangle above the symbol  appears throughout the duration.
- The time of day reappears in display F after release of button A.
- To request the remaining time, press my button A . The remaining operating time now appears in display F.

You should also be aware of the following

At the end, an audible tone sounds for around two minutes. You can prematurely cancel it by pressing button A .

The red triangle above button A  flashes. It is cancelled by pressing button A.

Precleaning the oven

Before using my oven for the first time, please clean all accessories (baking sheet, drip-pan, combination grid, etc.) with warm washing-up liquid suds. Then switch my heating mode switch to the top and bottom heat symbol  and my temperature switch to 250 °C and thus operate my empty oven with the door closed if possible for 1 hour.

The odour occurring is not harmful to the health. **To avoid any nuisance, you should ventilate your room well during this time.** When I have cooled down, please also clean my oven with warm washing-up liquid suds.

The user protection feature is intended to protect my hobs against any unauthorized use (child safety through two independent operations).

3 hours after the last operation of a hob switch, all hobs are automatically switched off.

If cooking is to proceed beyond this time, please press the user button with the hob switch switched on. The red pilot lamp comes on.

Owing to the safety precautions noted, please proceed as follows when using my hobs:

- Press user protection button
- Red pilot lamp comes on
- Switch on required hob(s) immediately thereafter.

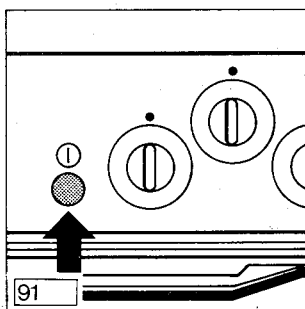

When cooking is to be ended, switch my hob switch(es) to the zero position.

Hob user protection

Switching on the hob user protection

Switching off the hob user protection

Hobs

Features

Depending on the features of the cooking area coordinated with me, you will find the following types of hobs:

High-speed hob

My cast iron hob is distinguished from standard cast iron hobs by its higher power. It therefore cooks faster. It is set as usual.

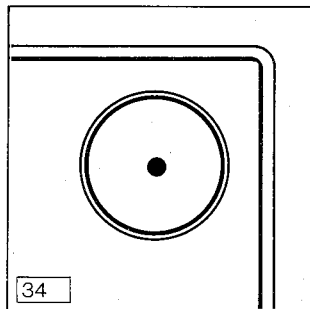

Glass-ceramic hob

The following are arranged below the extremely temperature-resistant glass-ceramic glass depending on cooking area model:

■ Single-circuit hob

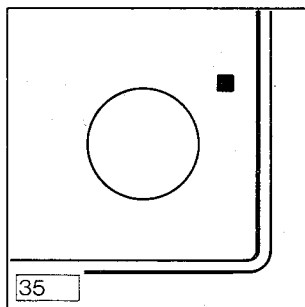

This hob is simply controlled by the coordinated switch arranged in the control panel.

■ Double-circuit hob

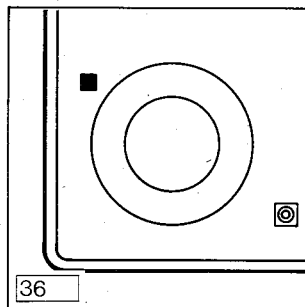

Only when the coordinated switch arranged in the control panel is switched on can the second hob circuit then be switched in with the **contact switch**.

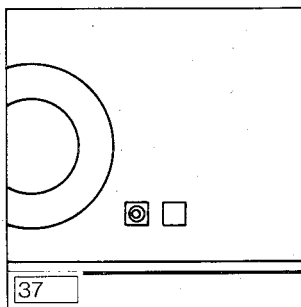

Both heating circuits are controlled and switched off by the switch in the control panel.

■ Frying zone

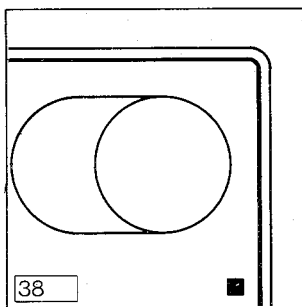

My heating system has a circular arrangement and is controlled by the coordinated switch arranged in the control panel, whereas the heating system for the frying zone is switched in with the **contact switch**.

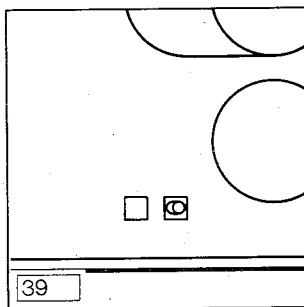

Both heating circuits are switched off by the switch in the control panel.

■ Halogen hob

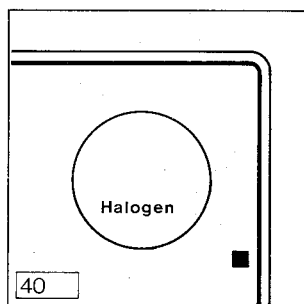

This hob is heated by a special high-intensity halogen lamp controlled by the coordinated switch arranged in the control panel.

■ Warming zone

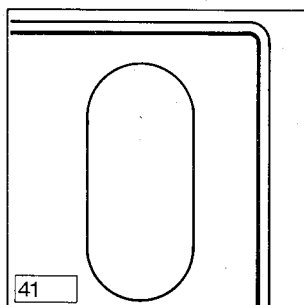

My zone intended for warming of crockery and food is switched both on and off by the **contact switch**.

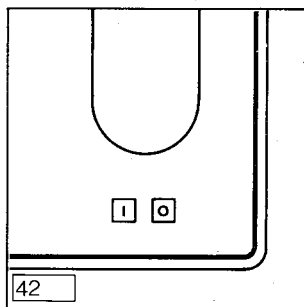

■ User guidance

Five symbols are coordinated with each of my hobs. Their light signals indicate the setting on which specific cooking sequences can be performed.

The symbols have the following meanings:

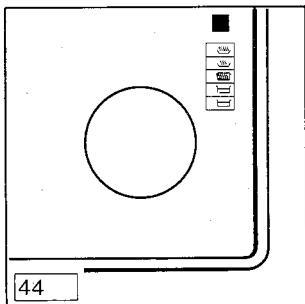

 Bringing to the boil and heavy frying

 Frying

 Steaming / boiling

 Creeping

 Melting

Please also follow the table when setting the automatic hobs.

■ Residual heat indicator

A light signal is coordinated with each of my glass-ceramic hobs, coming on when the hob is hot. The lamp goes out when the hob has cooled.

■ Oven fume (steam) outlet

The fume from my oven can escape through my cooking area openings at the rear. You will find more detailed instructions in the section describing the oven fume outlet on page 73.

**General
- Cookware**

The better the pot, the better the cooking result.

- You can tell good cookware by the pot bottom and not by the material from which the pot is made.
- The bottom should be as thick and flat as possible. It should also not be rough (as e.g. on cast-iron pots), since scratches arise when the pot is shifted.
- The pot bottom and hob must be of equal size. Please make sure that your cookware stands in the centre of the hob.

My hobs should always be clean, since soiled hobs and cookware bottoms not only damage my glass-ceramic cooking area (if available), but also increase power consumption.

Make good use of the afterheat by switching off the hob just before cooking ends.

You waste energy e.g. if ...

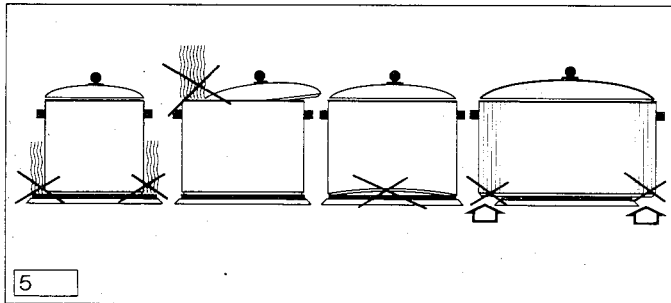

Pot
too small

Pot lid
not closed

Pot bottom
uneven

Pot too large
(glass-ceramic)

After switching on a hob, you will hear me buzz. This is a special feature of my radiant heating system not implying any impairment of function!

Never place food in aluminium foil or plastic containers on my hot cooking area. That has an extremely detrimental effect on the glass-ceramic cooking surface!

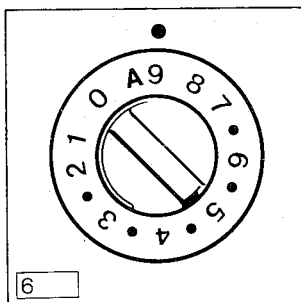

When **starting to fry**, set the switch referring to the hob to 9 until the fat is hot. Then place the food to be fried in the pan and turn the switch back to 6 or higher as necessary.

When **starting to boil**, set the switch referring to the hob to 9. To simmer, turn the switch back to 1 to 5 as necessary.

Intermediate settings, e. g. 3 • (or • 2 only with electronic indicator), are at all times possible.

When **starting to boil** within the 1-8 region (not on setting 9), my automatic system relieves you of the need to switch over to my simmering region if you turn the knob clockwise beyond setting 9 as far as letter A (the pilot lamp monitoring the boiling-up sequence comes on – if available) and then set it back to the required simmering region (1-8).

My automatic system selects for you the boiling-up time at the start of cooking and then itself switches back the power corresponding to the simmering setting selected.

The automatic system can be cancelled by turning to 0. You can also use my automatic hobs without the automatic system. You should then switch me on only as far as **setting 9**.

The following table shows you examples of the suitability of switch settings 1 to 9.

Operating the hob
– **Important note before starting**

– **Boiling/ frying on the automatic hob**

**Boiling/frying
table for the
automatic hob**

Switch setting	Suitable for
9	Boiling up large quantities of water. Boiling noodles
7-8	Deep fat frying of chipped potatoes. Fast frying of meat, e.g. goulash. Fritting of e.g. potatoes. Frying fillets, steaks
6-7	Frying of meat, schnitzels, Cordon Bleu, cutlets, pancakes, meatballs. Making roux. Light frying of sausages, liver, eggs. Deep-frying of doughnuts
4-5	Cooking large quantities of food, single-portion meals and soups. Steaming of potatoes. Making gravy
3-4	Steaming of vegetables or stewing of meat. Making rice pudding
2-3	Creeing of rice and milk puddings (stir occasionally). Steaming of small quantities of potatoes or vegetables. Heating of ready meals
1-2	Omelette, custard, sauce hollandaise. Keeping food warm. Melting of butter, chocolate, gelatine
0	Afterheat, off-position

Oven

General

Before using for the first time, please note the section describing precleaning of the oven **and the safety instructions for the user**. You can operate my oven with either traditional top and bottom heat, hot air, microwave, or in two (three) grilling modes, exactly as you wish and according to your recipe, since I have the practical type of convertible oven. You will find more detailed instructions under the methods of preparation.

The correct ovenware for your oven with microwave.

Combination mode (i. e. top/bottom heat, hot air, Infratherm grilling with microwave).

- The ovenware must be sufficiently temperature-resistant.
- **Glass, ceramics, porcelain, earthenware** (though without silver, gold, platinum, or other metal coatings).
- **Aluminium foil** (Important: when used with your microwave, aluminium foil must have a distance of at least 2 cm to the cooking space wall/door. Only use to protect projecting parts, e.g. the edges or drumsticks of poultry, against overcooking. **See cooking table.**)
- **Roasting bags** (please follow the respective manufacturer's instructions when using).
- **Grid with drip-pan** (accessory).
- **Microwave solo mode** (i. e. without heating).

Defrosting:

- **Glass, ceramics, porcelain, earthenware** (though without silver, gold, platinum, or other metal coatings).
- **Plastic ovenware** (please follow the respective manufacturer's instructions when using).
- **Paper cups**
- **Paper plates**
- **Parchment paper**
- **Cardboard**
- **Aluminium containers of ready meals** (Important: when used with your microwave, aluminium foil must have a distance of at least 2 cm to the cooking space wall/door.) Remove the lid beforehand! Defrost ready meals on porcelain or glass plates.
- **Roasting bags** (please follow the respective manufacturer's instructions when using).

Heating:

- **Glass, ceramics, porcelain, earthenware** (though without silver, gold, platinum, or other metal coatings).
- **Plastic ovenware** (please follow the respective manufacturer's instructions when using).
- **Paper cups** (risk of fire if subjected to prolonged heating!)
- **Paper plates** (risk of fire if subjected to prolonged heating!)

- **Parchment paper** (**risk of fire** if subjected to prolonged heating!)
- **Cardboard** (**risk of fire** if subjected to prolonged heating!)
- **Aluminium containers of ready meals** (Important: when used with your microwave, aluminium foil must have a distance of at least 2 cm to the cooking space wall/door.) Remove the lid beforehand!
- **Roasting bags** (please follow the respective manufacturer's instructions when using).

Cooking:

- **Glass, ceramics, porcelain, earthenware** (though without silver, gold, platinum, or other metal coatings).
- **Plastic ovenware** (please follow the respective manufacturer's instructions when using).
- **Aluminium containers of ready meals** (Important: when used with your microwave, aluminium foil must have a distance of at least 2 cm to the cooking space wall/door.) Remove the lid beforehand! Cook ready meals on porcelain or glass plates.
- **Roasting bags** (please follow the respective manufacturer's instructions when using).

My fume outlet in the cooking area (see illustration) can be opened or closed with the push-button. Please press my push-button only when the hobs are not operational to exclude the possibility of burning. Should you operate my push-button when the hobs are hot, however, we recommend you to use an object such as e. g. a cooking spoon to open or close.

- Fume outlet

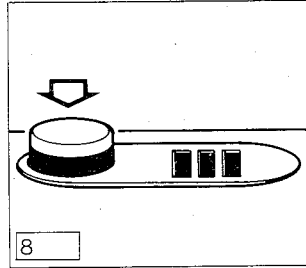

This enables you to control the humidity in my oven during baking or roasting and thus save yourself energy or even the need to add water.

Closed: **Push-button released, red edge visible**

Open: **Push-button pressed**

During preheating and during the first third of the time when baking bread or breadrolls, you should close my fume outlet to obtain better rising and browning.

During roasting, you should also keep my fume outlet closed, unless you want to achieve a crispy meat surface, as e. g. during the grilling of poultry.

The tables on baking and roasting contain more detailed instructions.

- Cooking functions

My cooking function options:

■ Top and bottom heat



In this mode, the heat uniformly radiates from above and below. Your roast turns out nicely crispy and succulent. You should always roast or bake only at one level, however, to ensure uniform application of heat.

■ Hot air



A fan ensures continuous circulation of uniformly hot air. Your cake receives the same intensity of heat from all sides, enabling you to roast, bake, and stew at max. three levels. You save time and also power owing to the low temperatures used.

■ Infratherm grilling



The grill attachment and fan are together in action! This enables you to grill or roast larger joints of meat and poultry at one level. This cooking function is also ideal for "au gratin" cooking and crisping-over.

■ Flat grilling





The grill attachment is fully utilized in this mode, e. g. for succulent steaks and schnitzels or for slices of halibut and salmon.

■ Double-circuit grill



(where featured)

Use my large grilling area  for high-speed grilling or toasting of larger quantities.

For smaller quantities, e. g. grilled steaks or possibly 4 slices of toast, it is sufficient to switch on my small grilling area (economy grill) .

■ Pyrolytic cleaning











(where featured)



During pyrolytic self-cleaning, the residues of roasting, grilling, or baking are converted into a loose dust which you can easily wipe out of my oven.

For safety reasons, the door is locked during the cleaning sequence.

Microwave combination modes (where featured)

- Microwave  with hot air 
This combination option enables you to prepare pastries and soufflés very quickly at one level.
- Microwave  with top and bottom heat 
This combination option is especially well-suited for items such as leek puddings, cheese cakes, etc.
- Microwave  with infratherm grilling 
A combination especially well-suited for roasting and grilling.
- Microwave  with flat grilling 
The combination option especially well-suited for e. g. the grilling of thick pieces, such as roast beef, chicken pieces, etc. or for the crisping-over of vegetables.

Microwave solo mode (where featured)

- Microwave solo mode 
This four-setting operating mode is outstandingly suitable for the cooking of vegetables, poaching of fish, and defrosting of frozen foods.
- Microwave solo mode 
The single-setting operating mode for fast defrosting of meat and fruit.

- Shelf levels

In the door of my baking carriage there are insertion hooks for my accessories. These accessories – combination grid, drip-pan, or baking sheets – can be inserted at 4 levels.

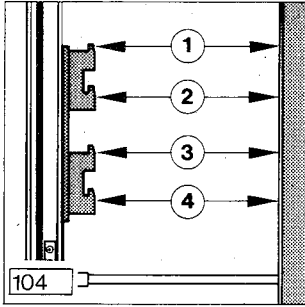

- Grease filter

The grease filter supplied protects my fan against soiling. It must always be inserted when

- I am heated by hot air (☞) and meat is being roasted in uncovered pans or on the grid (i.e. do not insert when baking!);
- during infratherm grilling (☒) in the drip-pan or grilling in an uncovered pan.

How to insert my grease filter:

Hold the grease filter by the grip and insert both retaining rings (see illustrations) from above downwards into the openings on the oven rear wall. Make sure that the grease filter exactly closes the opening. The grease filter must be cleaned from time to time. Briefly boil it with dishwasher cleaner or soft soap.

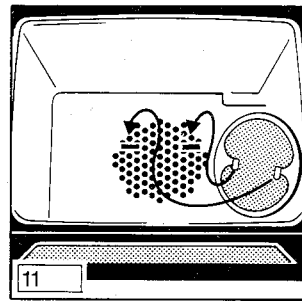
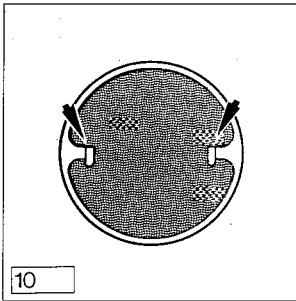

My electronic timer only switches the oven automatically on and off.

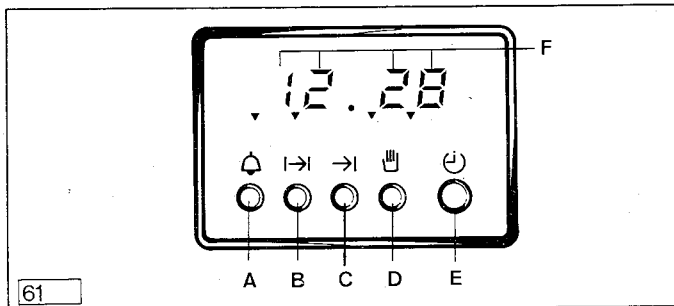





- Entry of the time for the **short-term alarm** (up to 23 hours and 59 minutes in advance)
- Manual** or **automatic operation** of oven
- Entry of the time for the **roasting** or **baking duration** (up to 23 hours and 59 minutes in advance)
- Entry of the clock time for the **roasting** or **baking time end** (up to 23 hours and 59 minutes in advance)
- Knob for time entries**
- Display symbol showing as long as time elapses

My symbols have the following meanings:

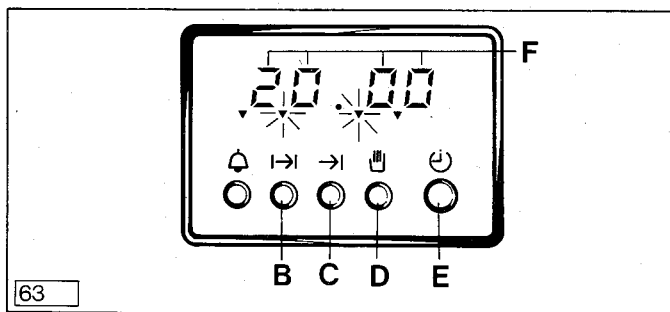
**How to program:
automatic
switch-off of
my oven**

**You should
also be aware
of the
following**



- Set my heating mode switch to the corresponding symbol and the oven temperature switch to the necessary temperature.
- Press my button B , hold it depressed, and enter the required **duration** with knob E . When my button B is released, the time of day reappears in display F.
- The red triangles above the symbols  and  show until the duration has elapsed.



My oven switches immediately on and automatically off after the elapsed duration.

At the end, an audible signal sounds for around two minutes. You can prematurely cancel it by pressing my button B .

When the roasting or baking process has ended, set my heating mode switch to 0 and the oven temperature switch to the Off position.







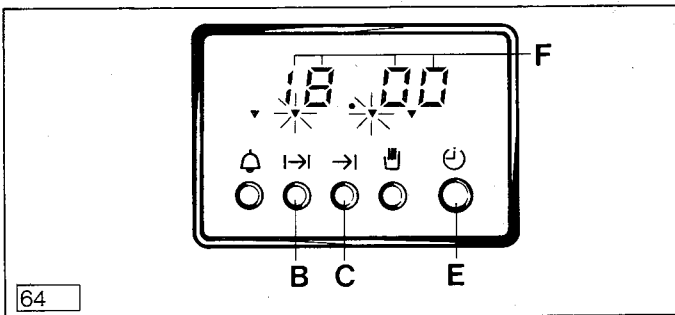

- The red triangle above button D  flashes. It is cancelled by pressing my button D.

My oven is ready to operate manually again.

You can request the **remaining duration** and **end** at any time during the automatic sequence. To do this, press either my button B  or C .

If you want to cancel automatic operation, press my button D , and set my heating mode and oven temperature switches to the 0 and Off position respectively.



- Set my heating mode and temperature switches as described above.
- Press my button B , hold it depressed and enter the required **duration** with knob E , and then, by pressing my button C , set the time to the point when the food being roasted or baked should be ready.
- When my buttons B  and C  are released, the time of day reappears in display F.
- The red triangles above the symbols , , and  show until the duration has elapsed.



My oven automatically switches on (end less duration) and off at the time set by you.

At the end, an audible signal sounds for around two minutes. You can prematurely cancel it by pressing my button B .

When the roasting and baking process has ended, set my heating mode switch to 0 and the oven temperature switch to the Off position.

- The red triangle above button D  flashes. It is cancelled by pressing my button D.

My oven is ready to operate manually again.

You can request the **remaining duration** and **end** at any time during the automatic sequence. To do this, press either my button B  or C .

If you want to cancel automatic operation, press my button D , and set my heating mode and oven temperature switches to the 0 and Off position respectively.

Automatic switch-on and -off of my oven

You should also be aware of the following

- Switching on and off

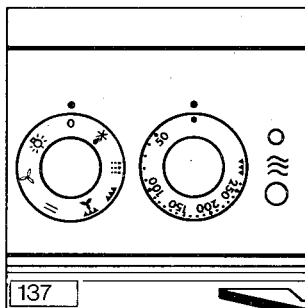

First decide with which heating mode you want to use my oven. Then set my switches – heating modes – to the corresponding symbol, for example  for hot air. Then turn my oven temperature switch to the necessary temperature. Turn this switch to the right to a higher temperature. The red pilot lamp shows as long as the oven is being heated and goes out as soon as the set temperature is attained. It comes back on when the oven is being reheated.

If you want to switch in my microwave, press my microwave button . My pilot lamp lights up.

With electronic timer: for defrosting  you can have the microwave switched off by my timer (see electronic timer).

If you preheat my oven (see corresponding note in the Tables), do not insert the food to be baked/roasted until the red pilot lamp first goes out. **Preheating is done without microwaves.**

To utilize the afterheat, you should switch off my oven around 5-10 minutes before the end of the baking/roasting time. To do this, turn my oven temperature switch to the left to the Off position and the heating mode switch to 0.

Important instructions on ovenware for microwave use

- **All ovenware** must be free from metal coatings, such as gold rims, silver decorations, or chrome-plated metal rings.
- Only use plastics, unless they are specially intended for microwave cooking, for brief defrosting or heating. They may cause fire on a long setting!
- Only use paper and board for brief heating or cooking. They may also cause fire on a long setting!
- Aluminium foil may be used to cover sensitive, projecting parts, e.g. the edges or drumsticks of poultry. **Caution: Make sure that there is a minimum distance of 2 cm to the door or side wall.**

The correct ovenware for microwave solo microwave combination modes

Ovenware	Defrosting	Operating modes		
		Microwave solo Heating	Cooking	Combination modes
Glass, heatproof	x	x	x	x
Glass-ceramic	x	x	x	x
Porcelain, heatproof	x	x	x	x
Earthenware	x	x	x	x
Plastics	○	○	-	-
Heat-resistant plastics specially intended for microwave use	x	x	x	○
Keep-fresh foil	-	-	-	-
Paper, board	○	○	-	-
Grid	x	x	x	x
Drip-pan	-	-	-	x
Baking sheet	-	-	-	x
Aluminium foil	○	○	○	○
Aluminium containers for menu cooking	○	○	○	○
Metal bakeware	-	-	-	-

x = suitable

- = unsuitable

○ = suitable in certain circumstances (see instructions)

Variable oven

My oven size (small oven) is arranged for everyday use.

This means that you can roast joints or poultry up to a size of **around 2 kg** and **bake at max. 2 levels.**

When you use me in this way, you make the following savings in comparison with conventional ovens:

Energy, time, and my cleaning is also easier for you, since you can detach the cover of my heated partition for cleaning.

While you are cooking in my upper oven, you can use the lower part for warming of crockery.

My lower oven is also suitable for the storage of unused accessories.

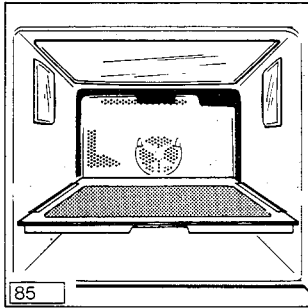

If you are roasting large joints or poultry – such as a goose or turkey – or baking at 3 levels, detach my heated partition to enlarge my oven.

If you remove my heated partition to enlarge my oven or for cleaning, **set my cooking function switch and oven temperature switch to 0 and the Off position respectively.** To remove my shelf, slightly lift this **forward (front side of oven)** and at the same time **pull it forwards out of my oven!**

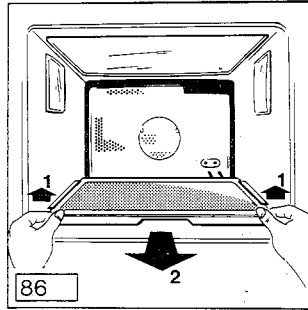

For your safety, my plug socket on the oven back panel is automatically closed when you take out the heated partition.

Important: Never insert my heated partition without a cover!

To remove the shelf

You should also be aware of the following

■ Baking at one or more levels.

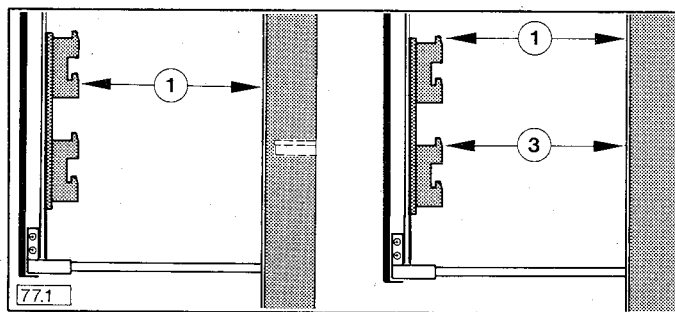



In the size-reduced oven, you can simultaneously bake on **2 baking sheets** and in the large oven on **3 baking sheets**.

You can obtain additional baking sheets and grids as special accessories. See page 103.

■ Bakeware:

You can use me to bake cakes either in baking forms or on baking sheets. The material from which the bakeware is made is extremely important.

The most important differences:

1. Black sheet baking forms, coated baking forms, or gold baking forms are the best, since they absorb heat and transfer it to the dough most rapidly, implying for you shorter baking times and lower power consumption.
2. White sheet baking forms reflect the heat, i.e. they repel it. Cakes which you bake in such forms have a longer baking time, do not become so nicely brown, and require a longer baking time. When baking with top/bottom heat, you should therefore not use white sheet baking forms.
3. In the combination mode of top/bottom heat  with micro-wave  (**where featured**). This cooking function is suitable for baking flans with a fruit topping and filling (cream or cottage cheese) as well as cakes with a low flour content (sponge, nut cakes).

It is not recommended to use this cooking function for baking with a high flour content (large cakes, almond cakes, or bread).

Use only glass, ceramic, porcelain, or heat-resistant plastic bakeware (without metal decorations).

Never use any metal bakeware!

The accessories provided are an exception!

■ Recommendations

Apart from cheesecakes, sponge cakes, and bread, I recommend hot air for everything else. It is more advantageous than by top and bottom heat.



In this heating mode, I bake at several levels simultaneously – quickly and economically – to save you time. I also bake different cakes at the same time, e.g. fruit cakes and almond cakes or large cakes and tartlets. You need only make sure that the prescribed temperatures for the various items roughly coincide. You should also take note that more steam arises when several baking sheets are inserted at any one time. This especially applies to fruit cakes. In the case of very moist fruit, e.g. damsons, therefore bake on only two sheets at most at any one time.

Baking – with top/ bottom heat



Baking – with hot air



- When using hot air  and microwave  combination mode **(if available)**.

This operating mode is suitable for the baking of cakes with fruit topping and cream or cottage cheese filling as well as for cakes with a low flour content (sponge and nut cakes).

It is not recommended to use this operating mode for cakes with a higher flour content (large cakes, almond cakes, or bread).

Use only glass, ceramic (glass-ceramic), porcelain, or heatproof plastic bakeware (without metal decorations).

**Never use any metal bakeware!
My supplied accessories are an exception!**



- Baking times and temperatures

During baking with hot air, it is also not necessary to preheat me for most types of cakes. Exceptions are indicated in the attached baking table.

If you want to bake different types of cakes at the same time, the prescribed temperatures should coincide. The baking times can be adapted by subsequent insertion or removal of items. During the initial period, the baking table will be of great assistance to you.

The recommended temperatures and times given in the attached table are guidance values. Deviations may possibly occur in practice.

When baking several cakes on baking sheets or in forms, you should prolong the time indicated in the table for one sheet or form by around 10-20 minutes.

- Hot air  and microwave  combination mode **(if available)**. In this operating mode, you can operate my oven only at one shelf level.



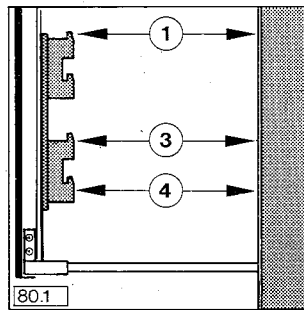
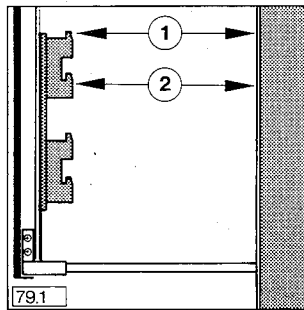
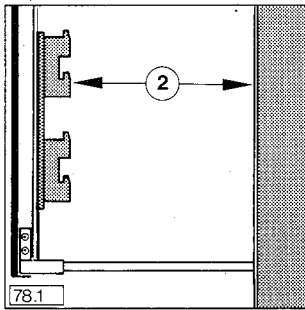

■ Baking at one or more levels



You can also simultaneously bake on 3 baking sheets.
You can obtain additional baking sheets and grids as special accessories (see page 103).

**Roasting
and steaming
- Heating
mode**

- Please choose the most favourable heating mode from my various options:

Top/bottom heat	
Hot air	
Infratherm grilling	
Microwave	 (if available).

The **bold type** in the **attached table** gives you the insertion level and temperature indications.

- Recommendations

For all 3 heating modes, the following applies:

Meat and fish should only be roasted in the oven from 1 kg weight. When preparing roast pork and pork chops with crackling, always place the scored roast in the upper part of the oven. When using drip-pans with a grid, liquid should be added where necessary (e.g. during prolonged roasting times) so that dripping fat and meat juices do not burn.

- Temperature, roasting/ grilling time

- The larger the roast which you entrust to me, the longer must the roasting or grilling time be set. The roasting/grilling times depend on the type, quantity, and quality of the meat. In practice, deviations from the indications given in the tables and recipes may therefore arise.
- So that any evaporated liquid can be supplemented, I recommend you during the roasting time to check your meat/fish from time to time.
- After around half the cooking time, the meat/poultry should be turned so that it is uniformly browned right round.

Combination operation with microwave (if available)

- During operation in combination with microwave, the cooking times are shortened by some 30-50%.
You will find more detailed information on roasting/grilling times and temperatures in the attached cooking chart booklet.
Note the instructions on the correct ovenware and ovenware material for microwave.

Flat grilling

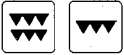



Recommendations

You can crisply grill all flat pieces of meat and fish which can also be fried in the pan and are not heavier than 1 kg: steaks, chops, etc. You should season large pieces of meat/fish shortly before grilling and small ones shortly afterwards.

Turn the slices of meat/fish after half the grilling time so that the slices are uniformly grilled on both sides. You need only turn flat slices and pieces once; larger round pieces should be turned several times.

Please insert my drip-pan and combination grid together in my 2nd level from above.

The indicated grilling times may only be guidance values, since, precisely during grilling, the times depend on the type and thickness of the food to be grilled and the degree of cooking.













On appliances with a double-circuit grill , you should set the grill to grill symbol  for small amounts and to symbol  for larger amounts.

Fume opening: open

You can clean the drip-pan and grid more easily by soaking my drip-pan/grid in washing-up liquid suds immediately after grilling.

Preheat my oven 5 min., and always grill with the oven door closed. You will thereby save power.

Flat grilling table

Type/quantity	Shelf height for drip pan/ grid, from above in each case	Grilling time		Insert grid
		1st side	2nd side	
Pork chop, pork schnitzel, meatballs, veal schnitzel, mutton and lamb chops	2nd	8-10 min.	6- 8 min.	
Pork fillet	2nd	10-12 min.	6-10 min.	
Frying sausage	2nd	8-10 min.	6- 8 min.	
Kebab	2nd	7- 8 min.	5- 6 min.	
Fillet steaks, veal steaks	2nd	6- 7 min.	5- 6 min.	
Fillet beef, roast beef				
(around 1 kg)	2nd	10-12 min.	10-12 min.	
Slices of liver	2nd	3- 4 min.	2- 3 min.	
Chicken, halved (around 500 g each)	3rd*)	10-15 min. inside	10-12 min. outside	
Fish fillet	2nd	6- 7 min.	4- 5 min.	
Trout, around 200-250 g each	2nd	4- 7 min.	3- 6 min.	
Toast	2nd	2- 3 min.	2- 3 min.	
Toasted snacks	2nd	6- 8 min.		

***) Remove intermediate floor of variable oven!**

**- Menu-cooking
in the large
oven**

■ **When menu cooking, please remove my heatable intermediate floor (if available).**

■ That is the truly amazing feature of my hot air oven. You can cook a complete menu all at once. Fish, meat, and dessert in one sequence. The fish does not taste of dessert, and the dessert does not taste of meat. Taste and smell do not mix.

■ The dishes you want to cook should need roughly the same cooking temperatures.

■ As soon as meat is cooked in an open vessel, please insert the **grease filter**.

Baked items indicated in the table as having around 20 °C lower temperatures can be coordinated with the meat dishes (see attached table on baking, roasting, and steaming). Differences of around 10 °C can be compensated by shorter or longer cooking times.

The **shelf height** must be selected depending on the individual foods to be cooked. Dishes with shortest cooking times should be inserted above. If several forms are to be placed above each other, a grid or drip-pan can be arbitrarily used to hold them.

Menu example:

Fume opening: open

Stuffed peppers with rice and cottage cheese soufflé.

Ovenware: Fireproof forms

Shelf heights: Rice and cottage cheese soufflé
level 1 from above
Stuffed peppers
level 2 from above

Heating mode: hot air

Temperature: 175-180 °C

Cooking time: around 1 hour
10 minutes
Afterheat: 5 minutes

- Bottling

- For bottling, use only commercially available bottling jars (jars with rubber rings and glass lids). Never use jars with screw fittings or bayonet catches or metal tins. And make sure you use fresh foodstuffs!

The oven holds 6 bottling jars of 1-1½ litres capacity.

Place 1 cup of hot water in the drip-pan so that the necessary humidity is retained in the oven.

- As the **shelf height**, use the 4th level from above. The jars should not touch, must wherever possible be filled to the same level with the same contents, and must be securely clamped.
- To **switch on**, turn my heating mode switch to hot air  and the oven temperature switch to 160 °C.

- **Fume opening: closed**

- **Keep an eye** on the food being bottled.

As soon as the liquid in the first jars (when bottling **fruit** or **pickled cucumbers**) **begins** to bubble (after around 45 minutes for 1-litre jars) switch off the oven, but allow the jars to stand a further 30 minutes or so – around 15 minutes for tender fruit, e.g. strawberries – in the closed oven.

When bottling **vegetables** or **meat**, set back my oven temperature switch to 100 °C as soon as the liquid in the first jars **begins** to bubble and allow the contents to **cook** for a further 60-90 minutes. Then switch off the oven with both my switches and allow the jars to stand a further 30 minutes in the closed oven.

- Defrosting Microwave solo

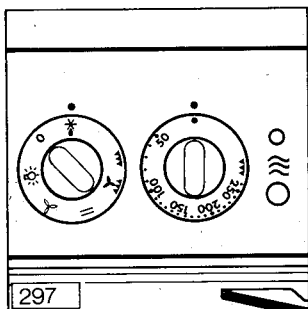

Basically the 3rd level from above should be used as the **shelf level**.

Defrosting

Meat:

Place the frozen, unpacked meat on an inverted plate in a glass or porcelain container so that the meat juice can freely drip.

Turn during the defrosting time. **Cover already defrosted areas with small pieces of aluminium foil.**

Important: During microwave operation, aluminium foil must have a distance of at least 2 cm to the cooking space/door.

Keep foil pieces at least 2 cm away from the cooking space walls and door. When the defrosting time has elapsed, the pieces of meat, depending on quality, need a differently long **standing time**.

Butter, pieces of layer cake, cottage cheese:

Remove aluminium packing foil beforehand.

Do not fully defrost in the appliance. Allow the food to attemperate outside (e.g. for pieces of layer cake and cottage cheese, for 30 minutes to 1 hour depending on quantity).

Fruit:







Carefully turn or stir during the defrosting time.















Ready-cooked dishes:

Never place any aluminium bowls on the grid.

Defrost ready-cooked dishes on porcelain or glass plate. Cover when defrosting and heat.

Defrosting table

Food to be defrosted	Quantity	Tips/remarks	Setting	Time min.	Standing time min.
Meat per piece	500 g	Turn twice, cover fatty areas with aluminium foil		10-12	20
Steak	200 g	Turn once		4- 5	5-10
Mince meat	500 g	Divide mince meat after 1st half of defrosting, placing inside pieces outside		8-10	10-12
Poultry	1000 g	Turn, cover drumsticks with aluminium foil		20-30	15-20
Fish fillet	400 g	Cover		8- 9	10-12
Strawberries, damsons, cherries, red-currants, apricots, etc.	500 g	Cover		10-12	10-15
Raspberries	250 g	Cover, stir once		7- 8	5-10

Type/quantity	Heat	Setting Temp.	Power %	Min.	Remarks/tips	Standing time min.
Bread						
4 breadrolls		200		3-4	Place on grid	5 in appliance
8-10 breadrolls		200		5-6	Turn occasionally	5 in appliance
White bread (around 150 g)		200		4-5	See above	5 in appliance
Wholemeal bread, mixed bread, brown bread, 1 slice (60-80 g)	-	-		1-1/2	Defrost individual slices covered	2-3 open
Bread (around 500 g)	-	-		6-8	Cover slice surface	15-20
Cakes						
Dry cake e.g. Madeira cake (around 300 g)	-	-		4-5	Allow cake to dry uncovered on a plate	5-10
Cake from baking sheet (around 350 g)		200		3-4	-	10 in appliance
Fruit cake baking sheet (400-450 g)		200		7-8	-	10 in appliance
1 piece cheese cake or covered apple tart	-	-		5-6	See above	10

Cleaning and care

If you have coordinated a glass-ceramic cooking area with me, a few principles should be observed despite its special virtue of being easy-care:

1. Never use aggressive cleaners, such as e.g. coarse scouring agents or abrasive pan cleaners.
2. Always clean the cooking area when it is lightly soiled – preferably after each use.
For this purpose, use a damp cloth and a little washing-up liquid. Then wipe the cooking area dry with a clean cloth. No cleaner residues should remain on the surface.
3. Thoroughly clean the whole cooking area once a week. For this purpose, use "Sidol Stainless Steel Gloss", "Steel-Fix", or "WK-Top".
Then thoroughly clean the whole cooking area with clean water and wipe dry with a clean cloth. Please make sure that no cleaner residues remain on the surface! The cooking area may otherwise be damaged!

Boiled-over food

First soften with a wet cloth and then remove the food residues with a **glass or razor-blade scraper**.

Then clean the cooking area as described under 3.

Burned-on sugar, melted plastic

Remove this at once – when still hot – with a glass scraper. Then clean the cooking area as described under 3.

You can prevent damage due to sugar or sugar-containing foods by caring for your glass-ceramic cooking area with Collo-Profi or Cerafix.

Stains

(Scale stains or mother-of-pearl-like glossy stains formed during cooking) are best removed when the hobs are still warm (not hot). For this purpose, also use "Sidol Stainless Steel Gloss", "Steel-Fix", or "WK-Top". Proceed exactly as described under 3.

Grains of sand or grit

which fall on to the cooking area may cause scratches when pots are moved about. Please make sure therefore that no grains or sand or grit remain on the cooking area.

You can obtain suitable cleaners, cleansing agents, and a glass scraper from the AEG Service Centre.

Glass-ceramic cooking area – Principles

– Special soiling

Cooking area with cast iron hobs

Please clean heavy soiling of the hobs with a fine scouring agent or sponge. Then lightly heat and allow to dry.

Please note that cleaners are unsuitable for the stainless steel edge of the cast iron hob and stainless steel tray, since they cause scratches.

Thermal loading during cooking may cause slight yellowing of the stainless steel edge and stainless steel tray. This depends on the physical nature of the material (its tendency to tarnish).

These discolorations can be easily removed with "WK-Top" or "Steelfix".

To care for your hobs, you can occasionally use a little sewing-machine oil (finally polish with paper) or other cleaners and cleansing agents, such as Collo-Elektrol, which you can obtain from the AEG Service Centre.

Never use butter, bacon, or the like!

Oven

■ Normal cleaning

Clean my oven after each use. This makes fat splashes easiest to remove. For stubborn soiling, use K2r Oven Cleaner, Huy, Collo Grille Cleaner, or Express Oven Cleaner.

To clean my glass-ceramic ceiling (if available), you can safely use oven spray or, for heavy soiling, a glass scraper.

Then wipe with clean water to remove all cleaner residues.

Never use aggressive cleaners, such as e.g. coarse scouring agents or abrasive pan cleaners. You can obtain suitable cleaners and cleansing agents from the AEG Service Centre.

Cleaning my heated partition

My heated partition should be removed for cleaning. The upper cover can be pulled out forwards and cleaned in the sink.

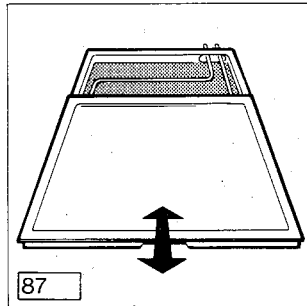

The heating element is clipped on to the lower part and can be removed by lifting. This allows easier wiping of the lower part.

Important: Never hold or place my heating element and the lower part of my partition in water or in a dishwasher!

After cleaning and drying, especially the heating element contacts, re-assemble the partition and slide it into the appropriate shelf level provided in my oven.

Important: My heated shelf may only be inserted in my oven complete (lower part with heating element and cover)!

Cleaning and replacing the light bulb(s)

Important: Switch off my fuses on the fixed wiring side (safety box) (remove screw-in fuses from holder).

To clean the glass covers and change my light bulb(s), **the glass cover should only be removed by hand!**

Important: Please never use any tools!

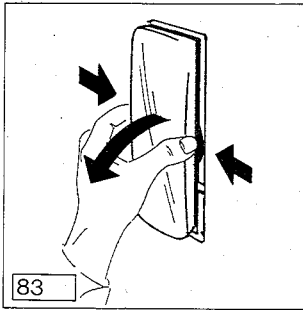

After changing the light bulb(s), clip the protective glass cover back in position.

Oven lighting

You can **illuminate** my oven for cleaning. To do this, turn my oven switch or my heating mode switch to the lamp position .

■ Thorough cleaning

For thorough cleaning, you can **detach various parts:**

- To detach the door:
Grip my door with both hands and pull it out of the guide bars **vertically upwards**. **Do not pull on the door handle!**

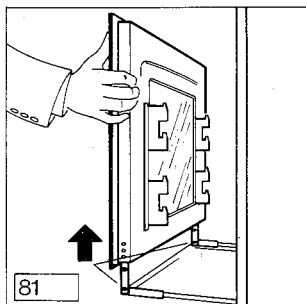

- To re-insert the door:
To insert my door, place it on the guide bars and push it in to its fullest extent.

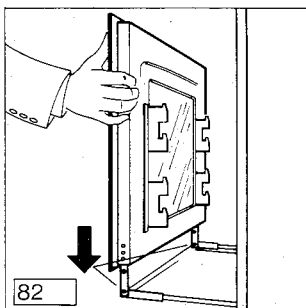

Detaching the baking carriage door

Folding grill combination

- Folding grill combination
My top heat grill combination can be folded down for cleaning of my oven ceiling.

Place all my switches in the 0 or Off position. Lower my grilling attachment only when there is no further risk burning.

Turn the 2 retaining hooks towards the centre. The grilling attachment swivels downwards so that you have easy access for cleaning of my oven ceiling (see illustration).

Important: Never use force when pressing down the grilling attachment. If force is used, the grilling attachment may break.

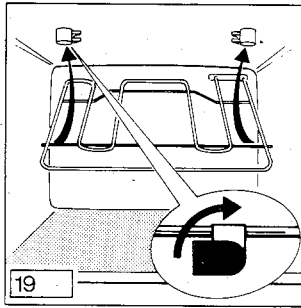

Then press the grilling attachment slightly upwards and swivel back the retaining hooks so that the grilling attachment holder is located between the jaws of the retaining hooks.

Cleaning the grease filter

- Grease filter
Boil the **grease filter** in water with dishwasher cleaner or soft soap.

Special accessories

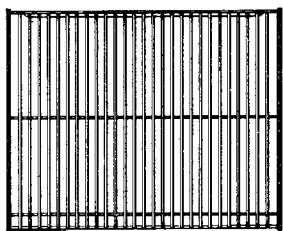

60

Second grid to hold bakeware
(baking carriage)
E-No.: 611 898 623



22

Baking sheet
(baking carriage)
E-No.: 611 898 621

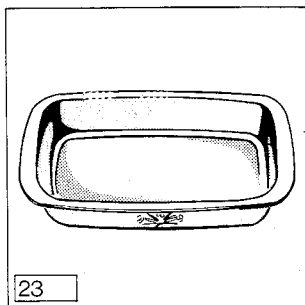

23

Glass-ceramic roast pan
(for placing on grid)
E-No.: 611 899 660

What to do if . . .

Faults you can rectify yourself

... the pilot lamps do not show?

... the oven does not heat?

1. You may well have not operated all relevant switches or
2. the fuse on the fixed wiring side (safety box) has blown.

... the fuses keep blowing?

Please call an approved electrical installer.

... the oven lighting fails?

See **Cleaning and care** on page 100.

Failure of my oven lamp(s) does not fall under the guarantee.

... the oven cannot be switched on?

Check whether:

... **my time of day** is flashing 00:00 or 0:00 in the display!
If yes, reset my time of day.

... **the audible tone of my timer** is emitting a continuous tone.
Then press the corresponding button to switch it off!

... **my timer display** does not show, but the pilot lamps of the appliance still show?

... **incorrect indications** appear in my display?

... **duration and end** cannot be entered!

An operating fault has occurred in my timer, or else there has been a short-term power failure.

Then remove/unscrew the wiring fuses of the appliance, **wait 30 seconds**, and then switch on/screw in the wiring fuses again.

Then reset the time of day in my electronic timer.

What to do if my 4 hobs fail?

... for this case, I have an emergency programme for my LH rear hob until the customer service engineer called by yourself arrives.

Important: My hob always operates at full power (1200 W) in the emergency programme, i.e. it is not controllable. Use my hob only under supervision.

Switching off the emergency circuit:

- Firmly press in (switch on) the push-button (illustration/ arrow) with a pointed object.
- Switch on the hob switch by turning clockwise.

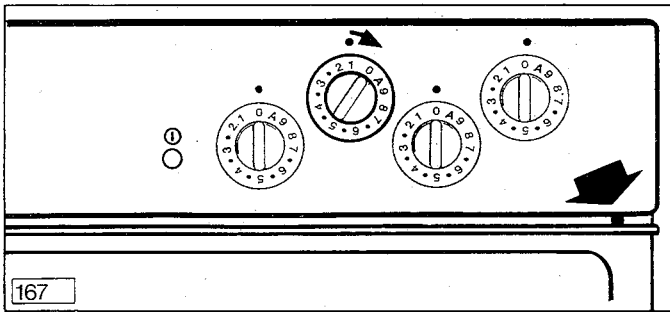

If, however, you decide to call in the service centre to help with any of the stated instructions or on grounds of faulty operation, the service engineer's visit cannot be made free of charge even during the guarantee period.

AEG electrical appliances comply with the valid safety requirements. Repairs to electrical appliances should only be performed by a trained electrician. Improper repairs may place the user at serious risk.

Customer service

If you cannot find any reference to a particular fault in my operating instructions, please contact our service centre.

When doing so, quote the E-No. and F-No. of your oven, which you will find on my rating plate/arrow.

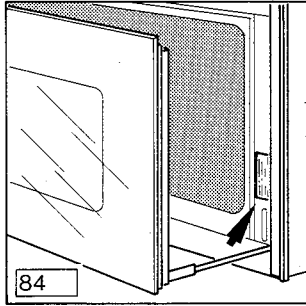

Your indication of these numbers enables the service centre to make precise identification of the required spare part so that I can be repaired at the engineer's first visit. You will thus save yourself additional costs due to any possible repeated trips by the service engineer.

So that these numbers are always to hand, you are recommended to enter them here.

E-No.

F-No.